

# GM1815

## SLOPING ROOF SHED

1830mm wide x 1530mm deep x 1980mm - 1830mm high

### BEFORE YOU BEGIN:

To avoid any confusion with your new shed build, we strongly suggest that you unpack and identify each part before you begin to put it together.

## ASSEMBLY INSTRUCTIONS

### YOU SHOULD HAVE ONE PACKAGE:

- 1 cardboard package

### TOOLS SUPPLIED:

- 1 riveter
- 3.3mm double ended drillbit

### TOOLS REQUIRED:

- Battery or electric drill (drill bits supplied)
- Tape measure
- Ladder
- Non-slip gloves, good shoes and goggles
- A set of helping hands



SCAN TO  
WATCH OUR  
ASSEMBLY VIDEO

**HERE**

Some parts have sharp edges and should be handled very carefully. We recommend the use of protective gloves and footwear when assembling.

DO NOT attempt to erect this shed in windy weather. All dimensions are approximate.

THIS SHED  
WAS PROUDLY  
PACKED BY:

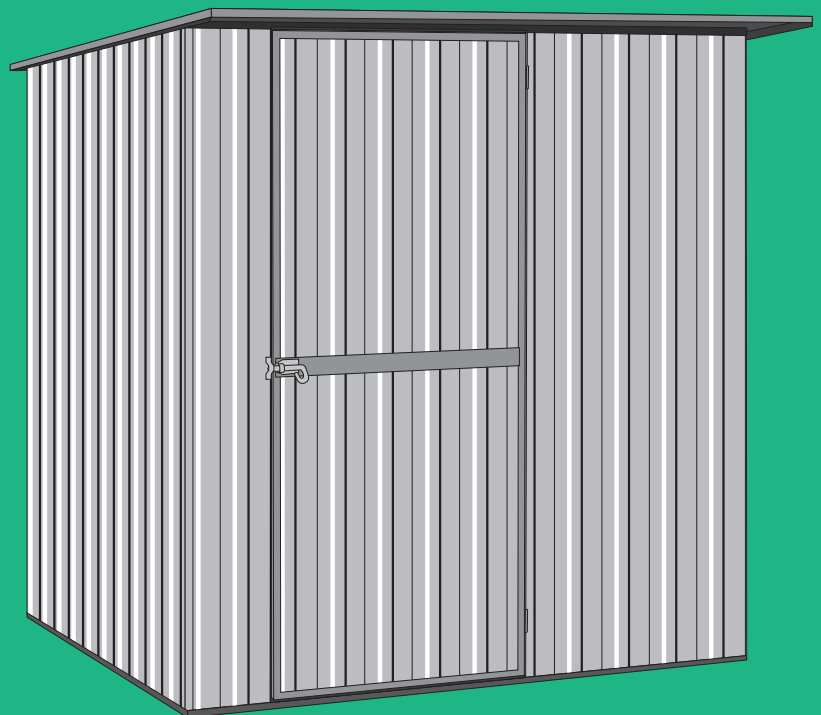

Please quote  
this code for any  
correspondence back  
to the supplier



CALL 0508 454 873  
for an installer near you

# COMPONENTS CHECKLIST

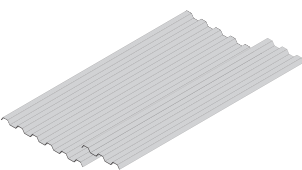
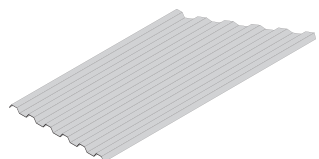
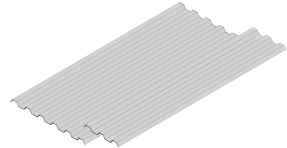
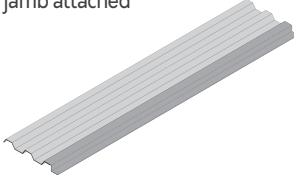
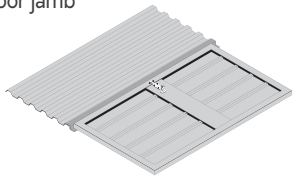
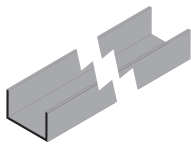
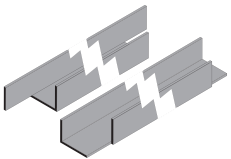
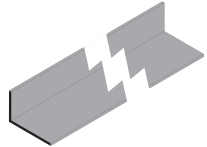
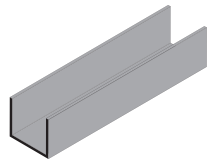
Please check the parts carefully and advise immediately if any are damaged or missing.

<p><b>A</b> 2½x 1830mm sheets for the back</p> 	<p><b>B</b> 4 x 1980mm - 1830mm sloping sheets (side walls 2 left, 2 right)</p> 	<p><b>C</b> 2½x 1830mm sheets for the roof</p> 	
<p><b>D</b> 1 x 330mm wide sheet with door jamb attached</p> 	<p><b>E</b> Door pre-hinged to 700mm sheet with door jamb</p> 	<p><b>F</b> 4 x 1515mm channels for end walls 2 x 1815mm channels for the roof</p> 	
<p><b>G</b> 4 x 1815mm channels with ends cut for front and back walls</p> 	<p><b>H</b> 2 x 1830mm 'L's for flashing the roof to the side walls</p> 	<p><b>I</b> 2 x 793mm door spacers</p> 	
<p><b>J</b> 1 x pack of rivets with padbolt for Zinalume sheds, rivets for colour sheds, 2 x 'Z' door braces and riveter for general assembly</p>			

## IMPORTANT!

- Remove the swarf (drill filings) from the panels as you assemble them.
- All components are cut to length. Do not cut any parts unless instructed.
- Rivets through the inside of the channels into the sheeting are just as important as rivets from the outside.

## RIBS AND PANS

- Generally most rivets are spaced at 300mm apart.
- Keep the rivets in the pans as close to the ribs as possible for added strength.
- Ribs will always protrude to the outside of the shed.
- Extra internal rivets are strongly recommended in high wind areas.

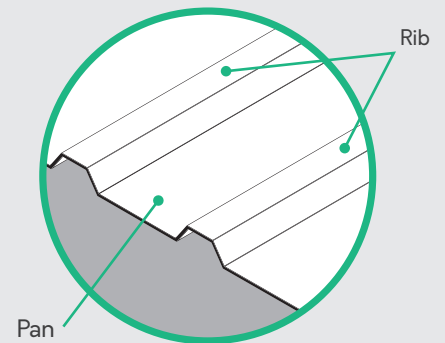

## BUILDING YOUR SHED

The basic task is to join the sheets together to form your panels, and rivet channels to the top and bottom of these panels. They will then join together to form your shed (diagram 1, 2 and 3).

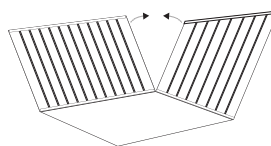

DIAGRAM 1

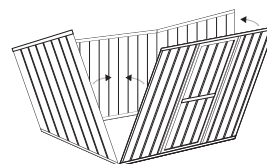

DIAGRAM 2

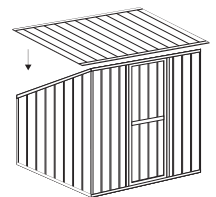

DIAGRAM 3

2



If you choose to vary from these instructions your warranty will be impaired.



If you need advice, call us **FREE** on **0800 807 433** or email us at [info@gardenmastersheds.co.nz](mailto:info@gardenmastersheds.co.nz)

# STEP 1: FRONT WALL

1. Slip **D** 330mm wide sheet with door jamb under door. Use **I** door spacer to determine the correct opening size by placing on the bottom flange of the door jambs. Then rivet **G** channels to tops and bottoms of sheeting.
2. **Outside:** Rivet channel at corners and every 2nd rib between and through door jambs and spacer.
3. **Inside:** One rivet per sheet at each end up through channel underside and through door jambs and spacer.

Rivet padbolt to the outside of door using wide flange rivets supplied.

## YOU WILL NEED:

- D** 1 x 330mm wide sheet with door jamb attached
- E** Door pre-hinged to 700mm sheet with door jamb
- G** 1 x 1815mm top channel  
1 x 1815mm bottom channel
- I** 2 x 793mm door spacers

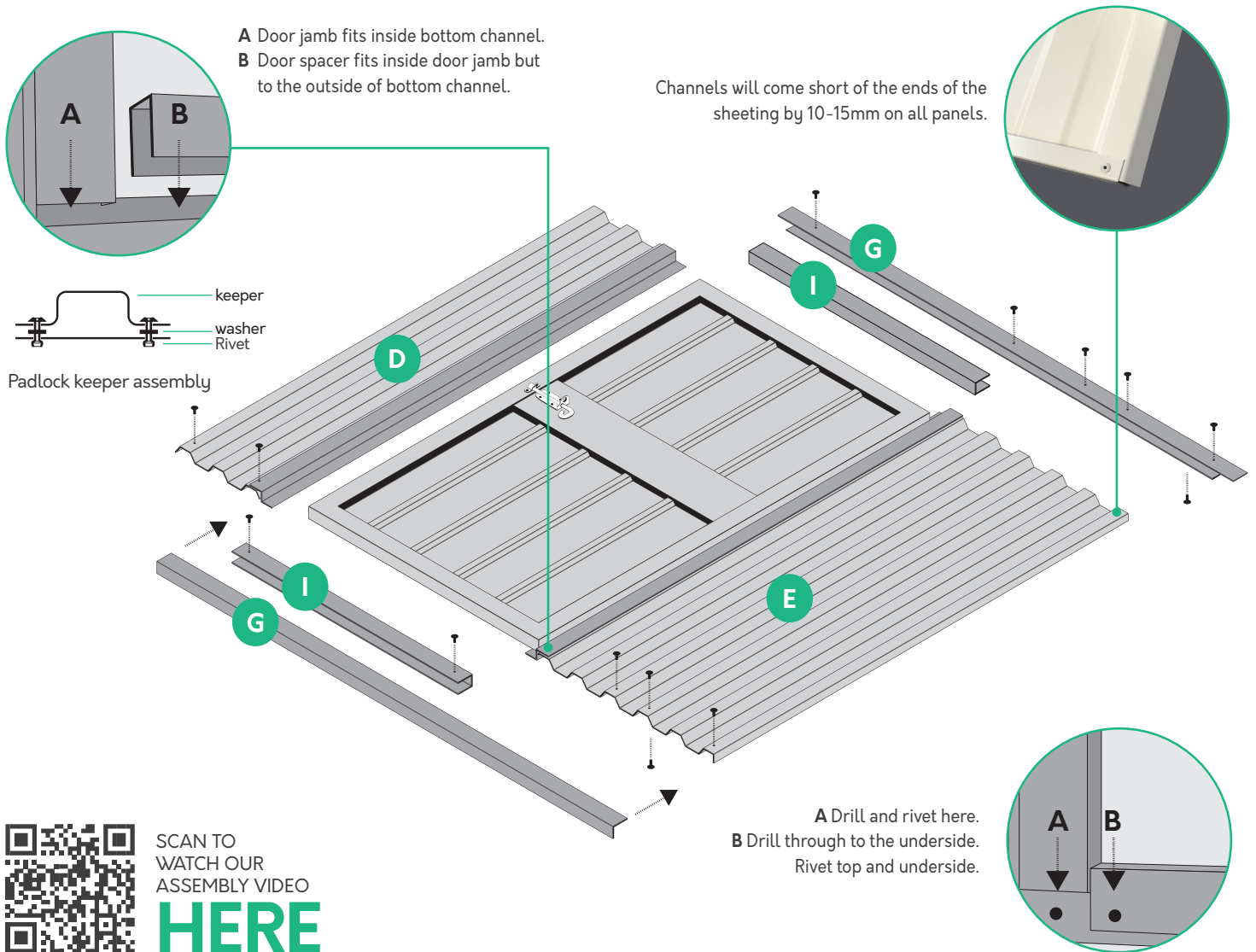

### FITTING CHANNELS

The higher side of the channel goes to the inside of the shed. It is very important to include the rivets on the underside of all the channels as they are structural (except roof channels).

OUTSIDE

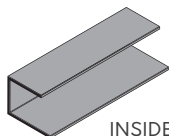

INSIDE

### CHANNELS WITH CUTOUTS

The cutouts go to the inside of the panel to allow easy fitment of the end walls on assembly.

TOP

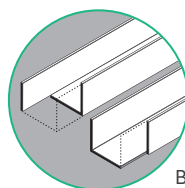

BOTTOM

### GARDEN MASTER TIP

To hinge the door on the opposite side, simply put the top channel on the bottom and the bottom on the top.

**Put the padbolt on the door before erecting the panels. It will stop the door swinging around!**



If you choose to vary from these instructions your warranty will be impaired.



If you need advice, call us **FREE** on **0800 807 433** or email us at [info@gardenmastersheds.co.nz](mailto:info@gardenmastersheds.co.nz)

## STEP 2: BACK WALL

1. Join 2 ½ **A** sheets together with 2 rivets through the overlapping ribs making sure the ends of the sheets are flush.
2. Cap sheeting with **G** channels putting the cutouts top and bottom same as the front wall.
3. Rivet the channels through the end ribs and every 2nd rib between.
4. Make sure you put at least 1 rivet per sheet up through the underside of the channel into the pan of the sheet.

### YOU WILL NEED:

- A** 2 ½ x 1830mm sheets for the back
- G** 1 x 1815mm top channel  
1 x 1815mm bottom channel

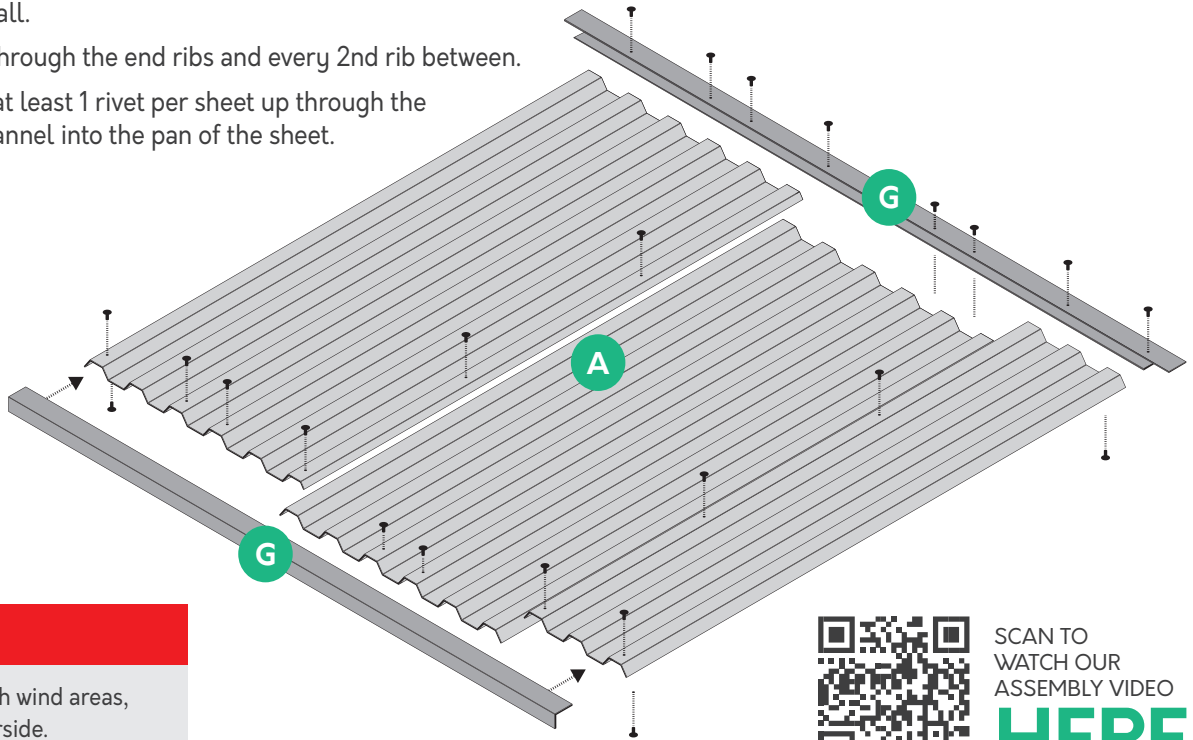

#### GARDEN MASTER TIP

Put extra rivets in for high wind areas, particularly on the underside.



SCAN TO  
WATCH OUR  
ASSEMBLY VIDEO  
**HERE**

## STEP 3: ROOF

1. Join 2 ½ **C** 1830mm sheets together, same as the back.
2. Cap sheeting with **F** 1815mm channels.
3. Rivet the channels at every second rib but not the corners at this stage.
4. Place the short flange of the 'L' on top of the rib at one end. Make sure ends are flush with sheeting (diagram 4) and put one rivet in the centre to hold the 'L'. Rivet the corners through the channels and one more between the corner and the centre rivet. Perform the same at the other end. 5 rivets for each 'L'.

### YOU WILL NEED:

- C** 2 ½ x 1830mm sheets
- F** 2 x 1815mm channels
- H** 2 x 1830mm 'L's

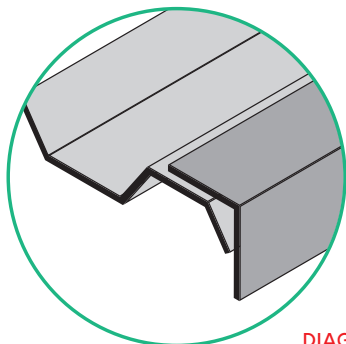
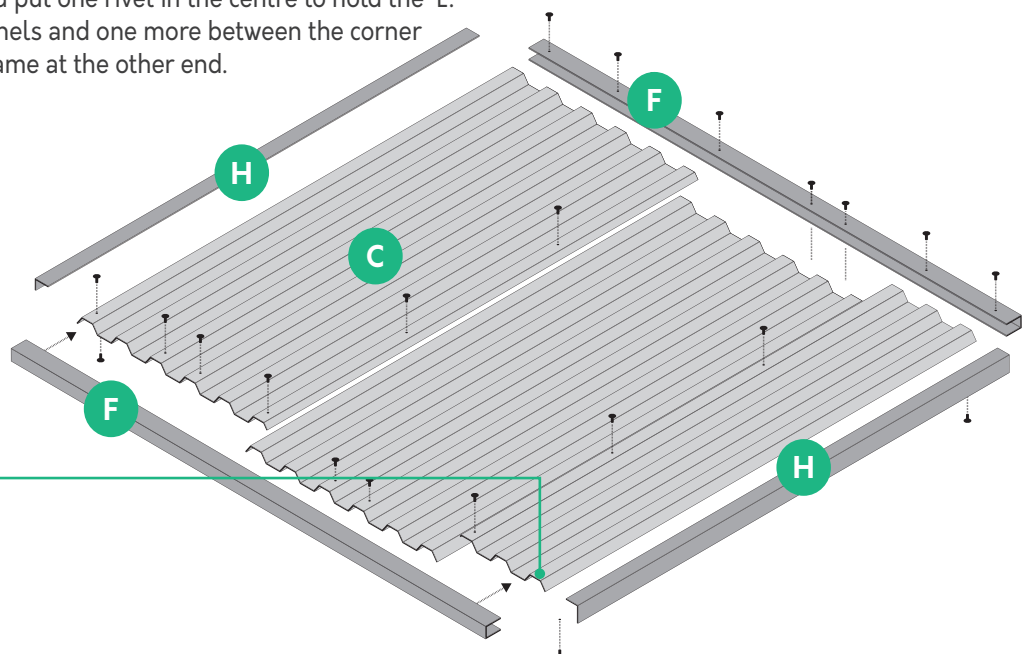

DIAGRAM 4



4



If you choose to vary from these instructions your warranty will be impaired.



If you need advice, call us **FREE** on **0800 807 433** or email us at [info@gardenmastersheds.co.nz](mailto:info@gardenmastersheds.co.nz)

# STEP 4: END WALLS

1. Cap the sloping sheets **B** with **F** 1515mm channels.
2. Rivet the channels at the corners and every 2nd rib in between.
3. 2 rivets up underneath through channel into pan of sheet.
4. Perform the same again for the other end.

## YOU WILL NEED:

- B** 4 x 1980mm - 1830mm sloping sheets (2 left, 2 right)
- F** 4 x 1515mm channels for end walls (2 per side)

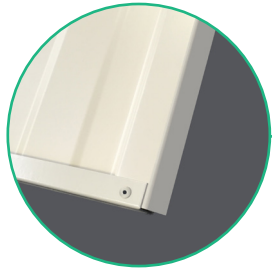

Channels will end 15-20mm short at tops of end walls and 10-15mm at bottoms.

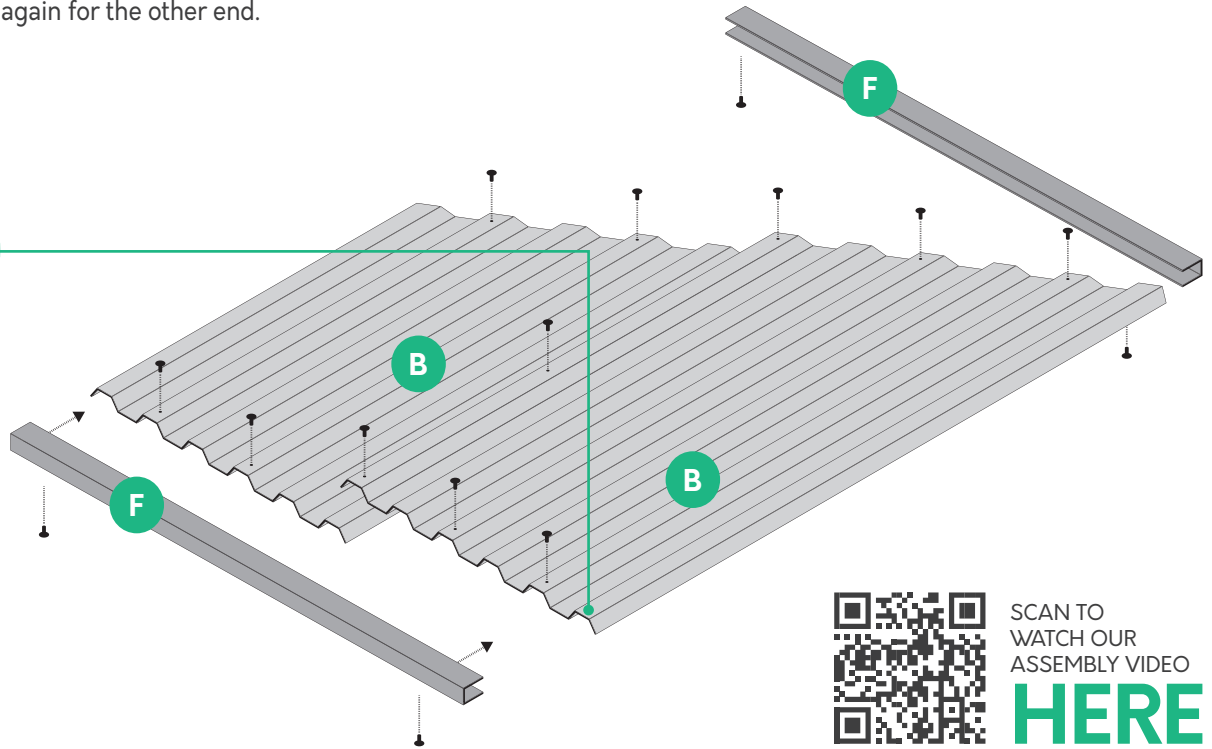

SCAN TO WATCH OUR ASSEMBLY VIDEO **HERE**

# STEP 5: DOOR BRACES

1. The door braces can be riveted now or after you have assembled your shed.
2. Tuck one end of the 'Z' between the bottom channel of the inside of the door and the sheet. Do the same at the top, overlapping in the centre behind the padbolt.

## YOU WILL NEED:

- J** 2 x 'Z' Door braces
- J** Rivets for Zincalume sheds
- J** Rivets for Colour sheds

**If you have a locking 'T' handle you will have to run the 'Z's the opposite way to the diagram.**

3. Rivet the 'Z's at the ends, and in the centre of the channel it is tucked under, and through the overlap in the centre. Two or three more rivets will be required through the door sheeting into the 'Z', but they will need to be riveted through from the outside of the door for a neater appearance.
4. You may need to cut or bend the flange at the bottom and the top of the 'Z' if it catches on the door jamb when opening or closing (diagram 5).

DIAGRAM 5

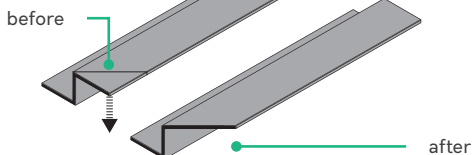

**ABOVE**  
Z door braces in position on the inside of door sheet

**!** If you choose to vary from these instructions your warranty will be impaired.

**i** If you need advice, call us **FREE** on **0800 807 433** or email us at [info@gardenmastersheds.co.nz](mailto:info@gardenmastersheds.co.nz)

# STEP 6: INSTALLATION

## WALL ASSEMBLY

Stand up the back wall and as your helping hand is holding it up, bring the left end wall in to meet it at the left corner (diagram 6) overlapping the corners (diagram 7).

Drill and rivet at approximately 100mm down from the top and up from the bottom, drilling and riveting from the outside.

Bring the right end wall into the right back corner and perform the same again, checking to make sure the walls are sitting flat at the bottom. Bring the front wall into place and join the front corners to the end walls, same as the back (diagram 8).

Finish joining the corners by riveting at approximately 200-300mm apart. You will find it easier to drill these corners if they are supported on the inside (see tip).

## FIXING THE ROOF

With a person at each end of the roof, lift it over the top of your upright walls and lower down on top with an overhang that looks best to you (diagram 9). At the left end rivet through the 'L' flashing into the top channel of the left end wall.

Measure the overhang at the back and rivet the right end 'L' to the right end wall with the same overhang as the left end. If it is difficult to get the same overhang at each end, this will be caused by an unlevel site or walls that are not square. Adjust accordingly. Rivet the 'L's at 300mm apart.

Using the ladder and the tape measure, rivet down through the top of the roof, through the pan into the top channel of the front and the back walls (10mm more than the overhang). Rivet beside every second rib. You will not need to worry about these rivets leaking as any water seeping through will end up on the outside of the walls.

## FIT THE DOOR BRACES AND INSTALL SHED

Fit the door braces, if not already done so. Check that all filings/swarf is removed.

## BUILDING YOUR SHED

The basic task is to join the sheets together to form your panels, then rivet the channels to the top and bottom of these panels. They will then join together to form your shed (diagram 6, 7, 8 and 9).

DIAGRAM 6

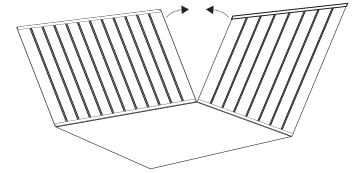

DIAGRAM 7

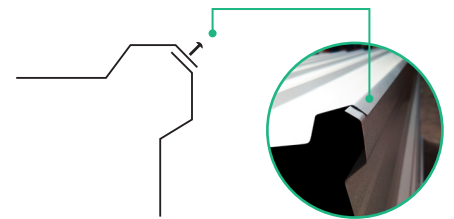

DIAGRAM 8

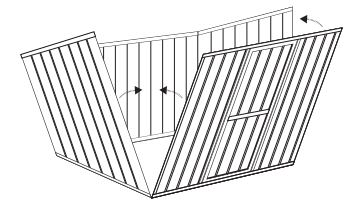
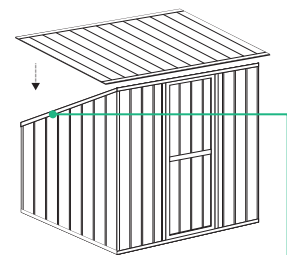

DIAGRAM 9



### L FLASHING

Rivet through the side of the 'L' flashing to secure the roof to the side of the shed.



## GARDEN MASTER TIP

Use the handle end of a hammer in the inside of the corner, but beware of drilling holes on the end of your hammer!

## IMPORTANT GARDEN MASTER HINTS & TIPS

### IMPORTANT: FIX YOUR SHED TO ITS FOUNDATIONS

If your foundations are unlevel or bowed, you will have problems with your padbolt and door levels. This can be fixed by slipping a spade under either door jamb and lifting. You will soon get a feel for which side needs propping up.

### IMPORTANT:

- Do not attempt to assemble panels in rain or windy conditions.
- Make sure your foundations are squared and level before erecting panels.
- It is easier to remove all swarf (filings) before you stand your walls up.
- Complete all panels before erecting your shed.
- Keep a firm grip on panels when handling. If they slip they will cause damage.
- Always wear non-slip gloves, protective footwear and eyewear.

It is essential that every shed has a floor, but the only way to make sure your shed is there to stay on windy sites is with a recessed concrete floor.

Phone **0800 807 433** for free advice or see page 7 for more details.



# STEP 7: COMPLETE YOUR SHED

## RECESSED CONCRETE FLOOR PLAN FOR SPECIALLY POURED CONCRETE FLOORS: SPECIFICATIONS

Every shed must have some type of foundation between it and the ground. You can pour a concrete floor and use recessed floor clamps, use an existing concrete base with flat floor clamps or purchase a kitset wooden floor from your shed dealer.

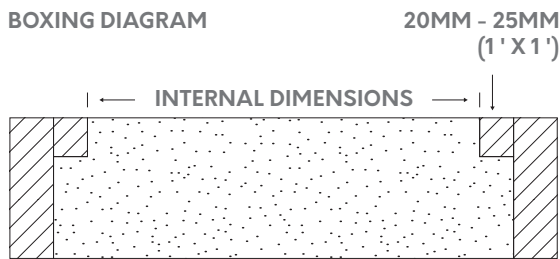
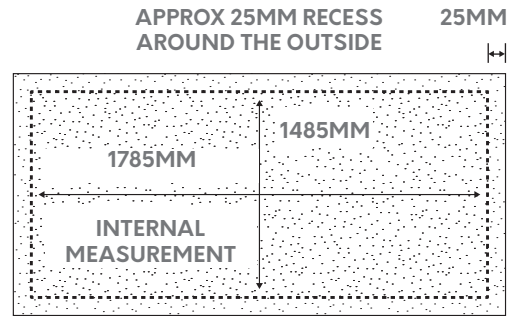
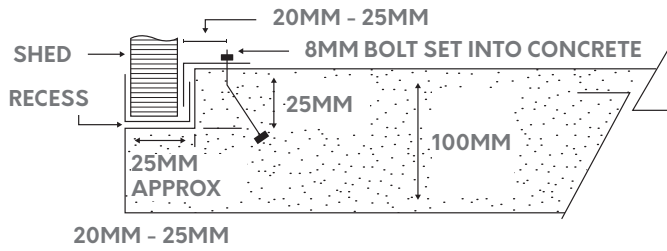

### RECESSED FLOOR CLAMPS

For poured floors with a recess around the perimeter. Available from your shed dealer.

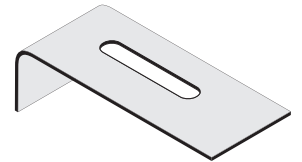

### INTERNAL DIMENSIONS FOR THE GM1815:

1785MM X 1485MM

### FLAT FLOOR CLAMPS

For existing concrete only. Water can seep underneath. Available from your shed dealer.

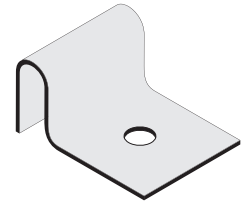

## KITSET WOODEN FLOORS

Every shed must have a floor. These are available from your local shed dealer.

For more information visit [www.gardenmastersheds.co.nz](http://www.gardenmastersheds.co.nz)

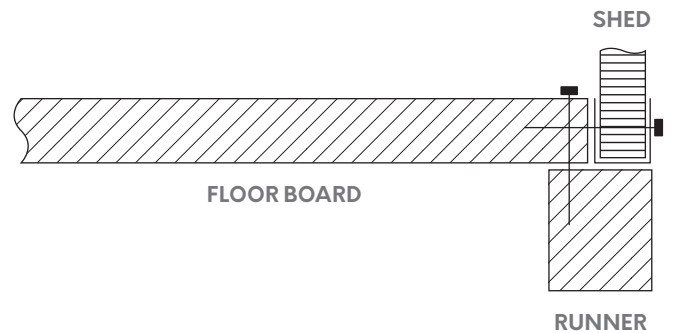
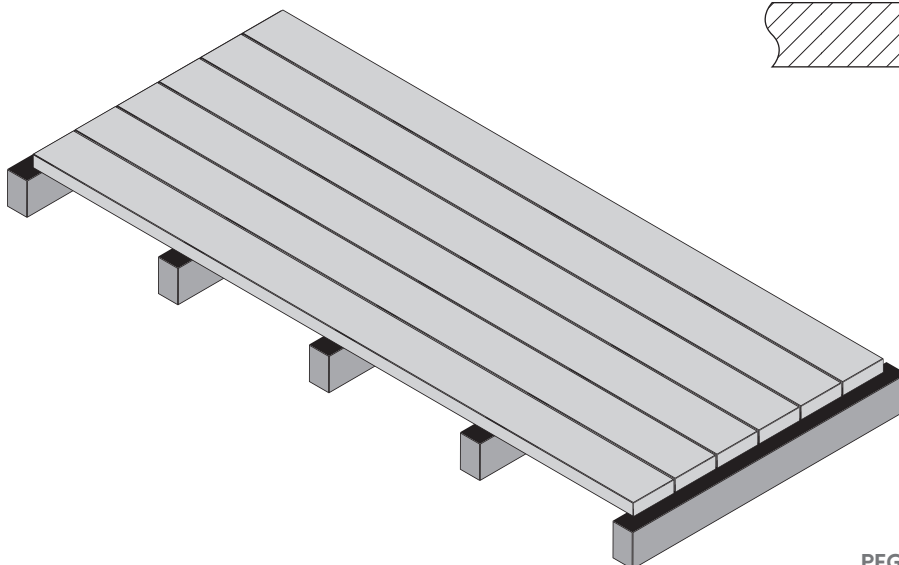

PEG THE FLOOR TO THE GROUND IN WINDY AREAS

**!** If you choose to vary from these instructions your warranty will be impaired.

**i** If you need advice, call us **FREE** on **0800 807 433** or email us at [info@gardenmastersheds.co.nz](mailto:info@gardenmastersheds.co.nz)

# WE WOULD REALLY LIKE YOUR FEEDBACK

Please email your comments to [feedback@gardenmastersheds.co.nz](mailto:feedback@gardenmastersheds.co.nz) or fax us on **06 878 5758**. Customer satisfaction is our top priority and we are always on the look out for ways in which we could do better.

## FREE GIFT

To receive your free gift, simply include your details when you send in your feedback, or send us a photo of your finished shed with your details.

## TO HELP YOU WE HAVE LISTED SOME QUESTIONS THAT YOU MAY LIKE TO ANSWER:

There is no need to type every question, only the question number and your answers are necessary for us.

1. How did you find out about us?
2. If you found us through our website, was it easy to navigate?
3. Did you find the assembly instructions easy to follow?
4. Where did you purchase your shed?
5. Was the sales person helpful and courteous?
6. What did you like best about your garden shed purchase?
7. Are there any parts of our service that you think we could improve upon?

## THANKS FOR YOUR HELP!

### GARDEN MASTER SHED OPTIONAL EXTRAS

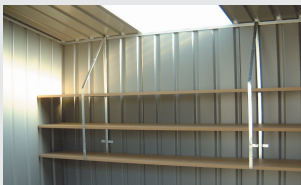

#### 1. SHELF BRACKETS

Hangs from the wall to allow maximum use of valuable floor space. Includes 3 x ply shelves, 1200mm x 300mm.

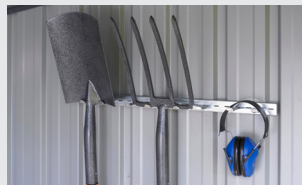

#### 2. TOOL RACKS

6 racks & 2 wallstrips. Keep your tools off the floor.



#### 3. FLOORS

We offer kitset wooden floors for every size of shed. Treated timber sits directly on the ground. The floor may need pegging into the ground in windy areas.



#### 4. HOOKS

Coming in a set of four.

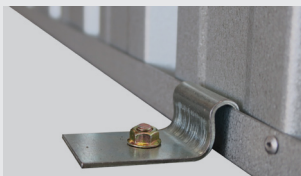

#### 5. FLAT FLOOR CLAMP

For existing flat concreted areas using dyna-bolts. (Bolts need to be ordered separately).



#### 6. RECESSED FLOOR CLAMPS

For specially poured concrete floors. We recommend the recessed concrete floor system as it provides greater protection from wind lift and moisture entering under your shed. (Pre-bent bolts available separately).

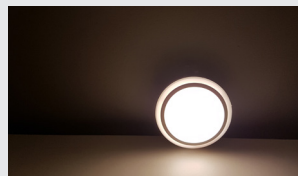

#### 7. RECHARGABLE LED SENSOR LIGHT

Handy for when the light is poor. Sensor automatically turns the unit on and off to ensure you can find what you need even at night.



#### 8. WORKBENCH

This sturdy workbench will be the perfect addition to your shed. Made from solid timber with a handy pegboard for your tools. (Tools not supplied).