



GM3818

SLOPING ROOF SHED

3770mm wide x 1830mm deep x 1980-1830mm high

ASSEMBLY INSTRUCTIONS

You should have two packages:

- 1 cardboard package
- 1 channel pack

Tools supplied:

- 1 Riveter
- 3.3mm double ended drillbit

Tools required:

- Battery or electric drill (drill bits supplied)
- Tape measure
- Ladder
- Non-slip gloves, good shoes and goggles
- A set of helping hands



SCAN TO
WATCH OUR
ASSEMBLY VIDEO
HERE

Call 0800 807 433
for an installer near you.



Some parts have sharp edges and should be handled very carefully. We recommend the use of protective gloves and footwear when assembling. **DO NOT** attempt to erect this shed in windy weather. All dimensions are approximate.

Components checklist

Please check the parts carefully and advise immediately if any are damaged or missing.

- A** 5 x 1830mm sheets for the back and 2 x 1980mm sheet for the front

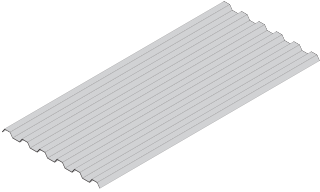

- B** 4 x sloping sheets and 2 x 1/2 sheets for end walls (2 1/2 left, 2 1/2 right)

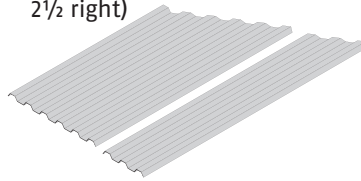

- C** 5 x 1980mm long sheets for the roof

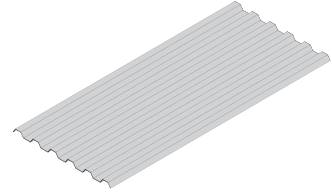

- D** 1 x 740mm wide sheet with door jamb attached

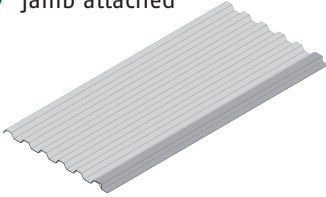

- E** Door pre-hinged to 2nd 740mm sheet with door jamb

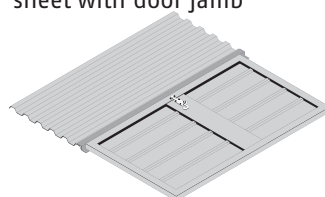

- F** 4 x 1815mm channels for end walls 2 x 3745mm channels for the roof

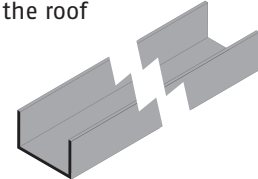

- G** 4 x 3745mm channels with ends cut for front and back walls

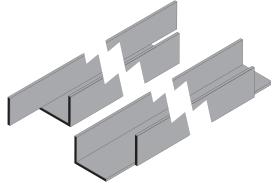

- H** 2 x 1980mm 'L's for flashing the roof to the side walls

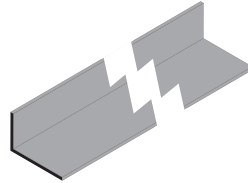

- I** 2 x 793mm door spacers

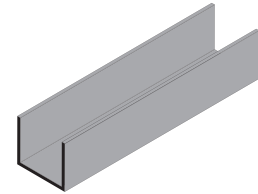

- J** 1 x pack of rivets with padbolt for Zinalume sheds, rivets for colour sheds, 2 x 'Z' door braces and riveter for general assembly



Building your shed

The basic task is to join the sheets together to form your panels, and rivet channels to the top and bottom of these panels. They will then join together to form your shed (diagram 1, 2 and 3).

diagram 1

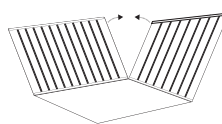
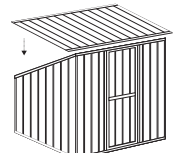

diagram 2



diagram 3



Important

- Remove the swarf (drill filings) from the panels as you assemble them.
- All components are cut to length. Do not cut any parts unless instructed.
- Rivets through the inside of the channels into the sheeting are just as important as rivets from the outside.

Ribs and Pans

- Generally most rivets are spaced at 300mm apart.
- Keep the rivets in the pans as close to the ribs as possible for added strength.
- Ribs will always protrude to the outside of the shed.
- Extra internal rivets are strongly recommended in high wind areas.

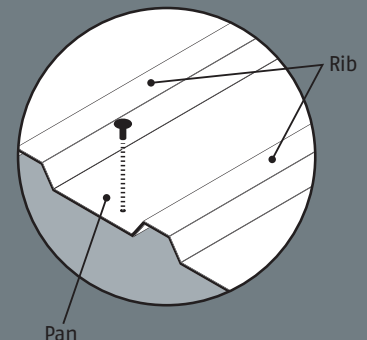

1 If you choose to vary from these instructions your warranty will be impaired.

If you need advice, call us FREE on 0800 807 433 or email us at info@gardenmastersheds.co.nz

Step 1: Front wall

1. Join 2 **A** 1980mm sheets to (D) or (E) 740mm sheet depending on which way door is to swing. Slip **D** 740mm wide sheet with door jamb under door. Use **I** door spacer to determine the correct opening size by placing on the bottom flange of the door jambs. Then rivet **G** channels to tops and bottoms of sheeting.
2. **Outside:** Rivet channels at corners and every 2nd rib between and through door jambs and spacer.
3. **Inside:** One rivet per sheet at each end up through channel underside and through door jambs and spacer.
4. Rivet padbolt to the outside of door using wide flange rivets supplied.

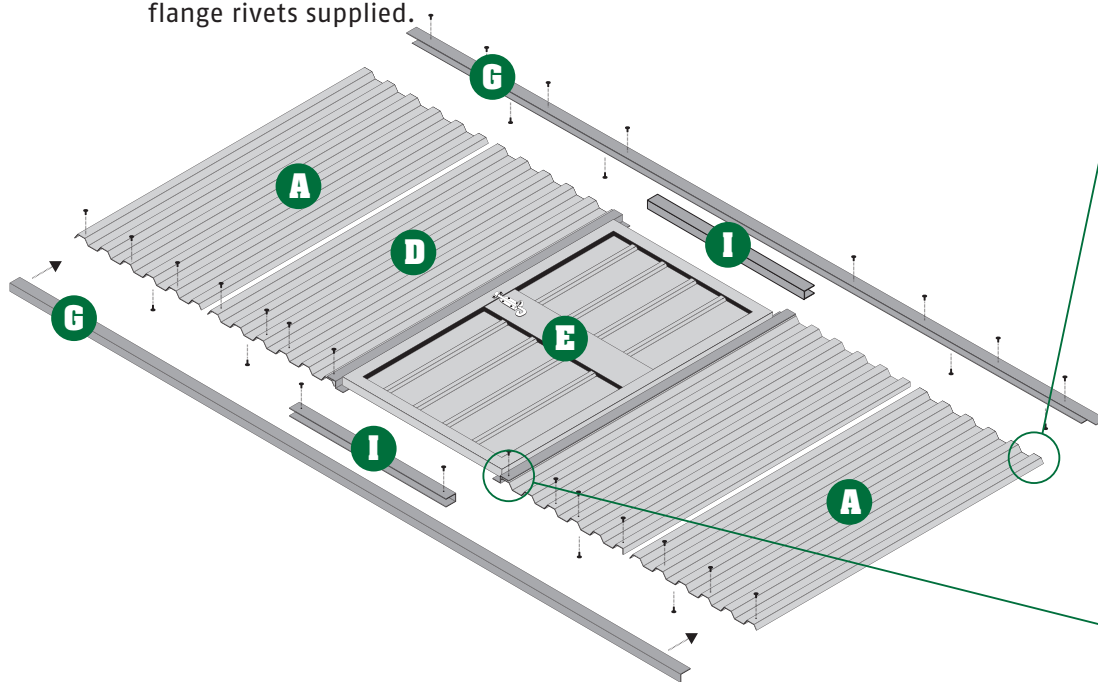

You will need:

- A** 2 x 1980mm sheets.
- D** 1 x 740mm wide sheet with door jamb attached.
- E** Door pre-hinged to 740mm sheet with door jamb.
- G** 1 x 3745mm top channel.
1 x 3745mm bottom channel.
- I** 2 x 793mm door spacers.

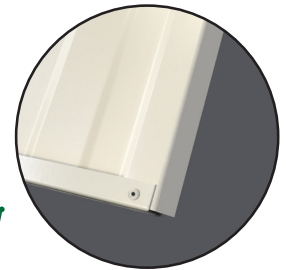

Channels will come short of the ends of the sheeting by 10-15mm on all panels.

Fitting:

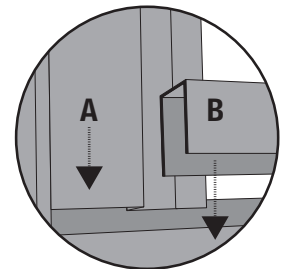

- A** Door jamb fits inside bottom channel.
- B** Door spacer fits inside door jamb but to the outside of bottom channel.

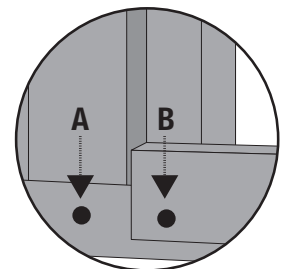

- A** Drill and rivet here.
- B** Drill through to the underside. Rivet top and underside.

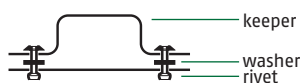

Padlock keeper assembly

The higher side of the channel goes to the inside of the shed. It is very important to include the rivets on the underside of all the channels as they are structural (except roof channels).

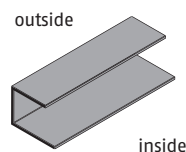

Tips

- To hinge the door on the opposite side, simply put the top channel on the bottom and the bottom on the top.
- Put the padbolt on the door before erecting the panels. It will stop the door swinging around!

Note

The cutouts go to the inside of the panel to allow easy fitment of the end walls on assembly (page 5).

- G** Channels with cutouts

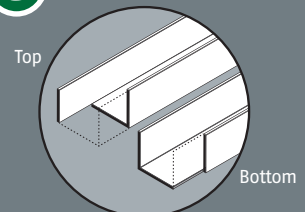

Step 2: Back wall

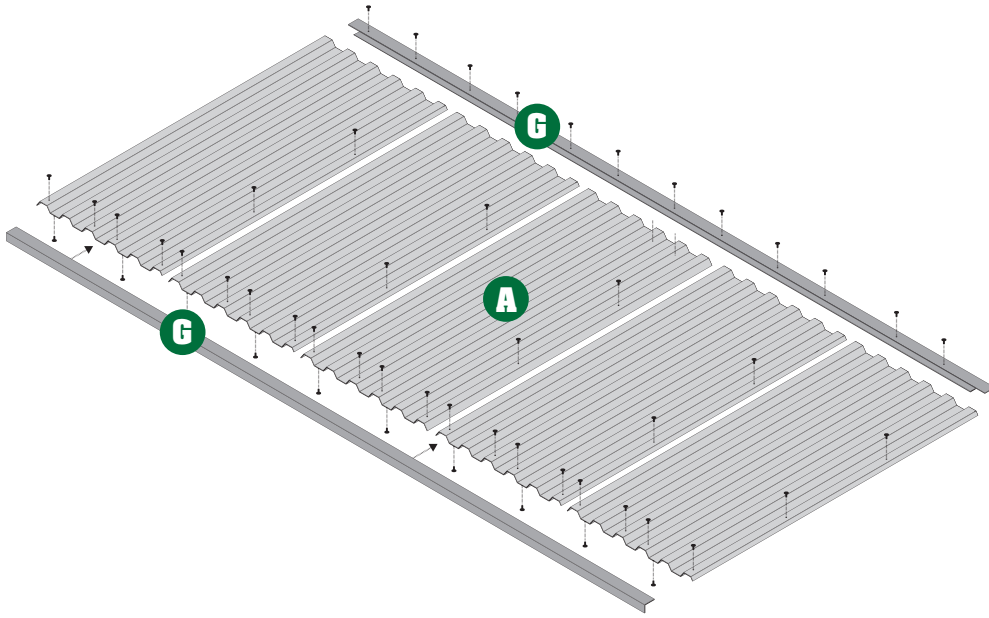

You will need:

- A** 5 x 1830mm sheets for the back.
- G** 1 x 3745mm top channel.
1 x 3745mm bottom channel.

- 1.** Join 5 **A** sheets together with 2 rivets through the overlapping ribs making sure the ends of the sheets are flush.
- 2.** Cap sheeting with **G** channels putting the cutouts top and bottom same as the front wall.
- 3.** Rivet the channels through the end ribs and every 2nd rib between.
- 4.** Make sure you put at least 1 rivet per sheet up through the underside of the channel into the pan of the sheet.

Tip

Put extra rivets in for high wind areas, particularly on the underside.

Step 3: Roof

- 1.** Join 5 **C** 1980mm sheets together, same as the back.
- 2.** Cap sheeting with **F** 3745mm channels.
- 3.** Rivet the channels at every second rib but not the corners at this stage.
- 4.** Place the short flange of the 'L' on top of the rib at one end. Make sure ends are flush with sheeting (diagram 1) and put one rivet in the centre to hold the 'L'. Rivet the corners through the channels and one more between the corner and the centre rivet. Perform the same at the other end. 5 rivets for each 'L'.

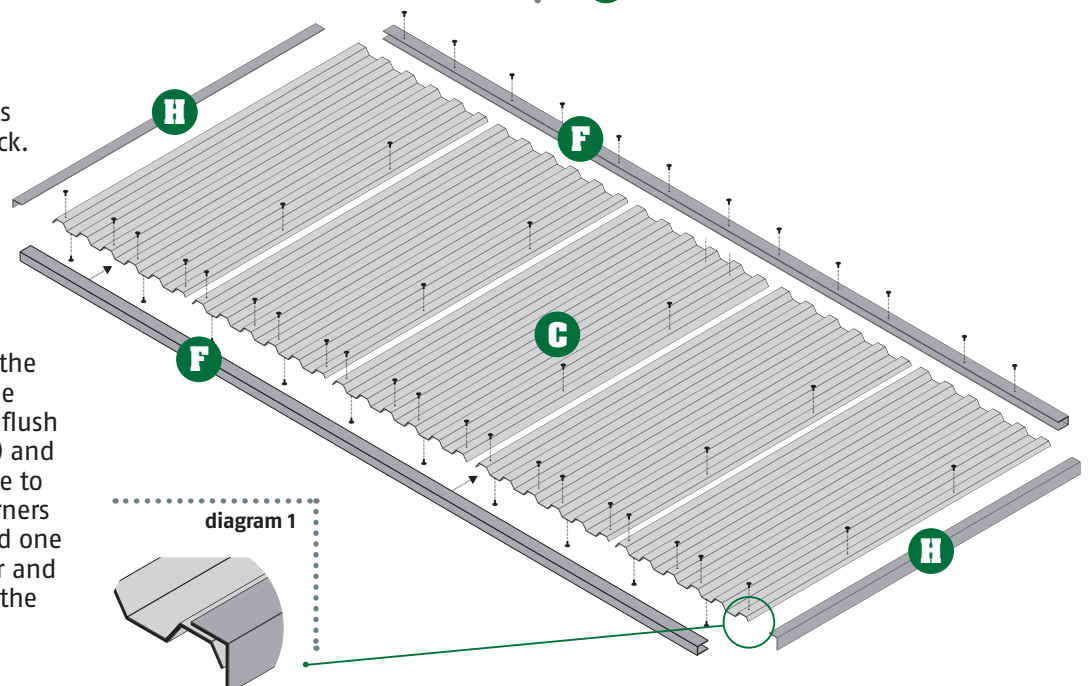

You will need:

- C** 5 x 1980mm long sheets.
- F** 2 x 3745mm channels.
- H** 2 x 1980mm 'L's.

3  If you choose to vary from these instructions your warranty will be impaired.

 If you need advice, call us FREE on 0800 807 433 or email us at info@gardenmastersheds.co.nz

Step 4: End walls

You will need:

- B** 4 x sloping sheets and 2 x 1/2 sheets for end walls (2 1/2 left, 2 1/2 right)
- F** 4 x 1815mm channels (2 per side).

1. Cap the sloping sheets **B** with **F** 1815mm channels.
2. Rivet the channels at the corners and every 2nd rib in between.
3. 2 rivets up underneath through channel into pan of sheet.
4. Perform the same again for the other end.

Channels will end 15-20mm short at tops of end walls and 10-15mm at bottoms.

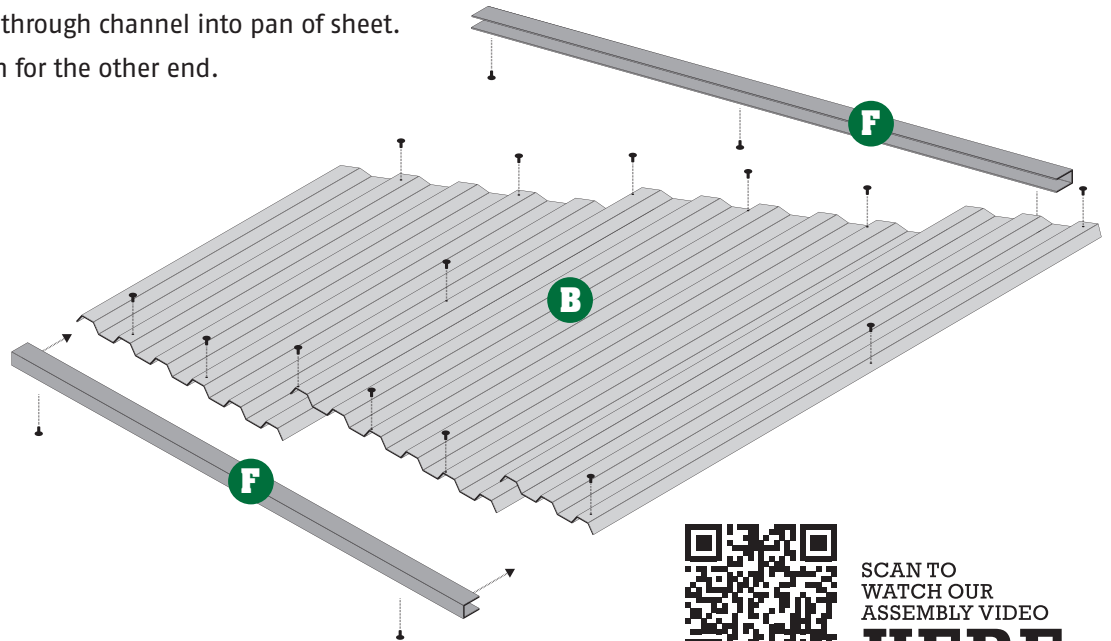
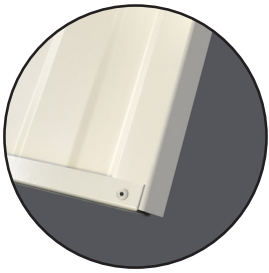

SCAN TO
WATCH OUR
ASSEMBLY VIDEO
HERE

Step 5: Door braces

You will need:

- J** 2 x 'Z' Door braces.
- J** Rivets for Zincolume sheds.
- J** Rivets for Colour sheds.

1. The door braces can be fitted now **or** after you have assembled your shed.
2. Tuck one end of the 'Z' between the bottom channel of the inside of the door and the sheet. Do the same at the top, overlapping in the centre behind the padbolt. If you have a locking 'T' handle you will have to run the 'Z's the opposite way to the diagram.
3. Rivet the 'Z's at the ends, and in the centre of the channel it is tucked under, and through the overlap in the centre. Two or three more rivets will be required through the door sheeting into the 'Z', but they will need to be riveted through from the outside of the door for a neater appearance.
4. You may need to cut or bend the flange at the bottom and the top of the 'Z' if it catches on the door jamb when opening or closing (diagram 1).

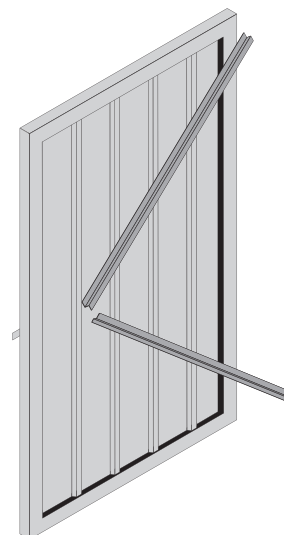
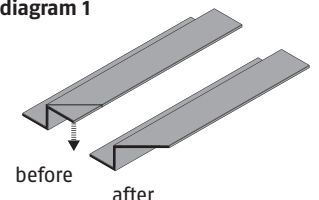

diagram 1



! If you choose to vary from these instructions your warranty will be impaired.

i If you need advice, call us FREE on 0800 807 433 or email us at info@gardenmastersheds.co.nz

Step 6: Installation

Wall assembly

1. Stand up the back wall and as your helping hand is holding it up, bring the left end wall in to meet it at the left corner (diagram 1) overlapping the corners (diagram 2). Drill and rivet at approximately 100mm down from the top and up from the bottom, drilling and riveting from the outside.
2. Bring the right end wall into the right back corner and perform the same again, checking to make sure the walls are sitting flat at the bottom.
3. Bring the front wall into place and join the front corners to the end walls, same as the back (diagram 3).
4. Finish joining the corners by riveting at approximately 200–300mm apart. You will find it easier to drill these corners if they are supported on the inside (see tip).

Fixing the roof

5. With a person at each end of the roof, lift it over the top of your upright walls and lower down on top with an overhang that looks best to you (diagram 4). At the left end rivet through the 'L' flashing into the top channel of the left end wall. Measure the overhang at the back and rivet the right end 'L' to the right end wall with the same overhang as the left end. If it is difficult to get the same overhang at each end, this will be caused by an unlevel site or walls that are not square. Adjust accordingly. Rivet the 'L's at 300mm apart.
6. Using the ladder and the tape measure, rivet down through the top of the roof, through the pan into the top channel of the front and the back walls (10mm more than the overhang). Rivet beside every second rib. You will not need to worry about these rivets leaking as any water seeping through these rivets will end up on the outside of the walls.

Fit the door braces and install shed

7. Fit the door braces, if not already done so. Check that all filings/swarf is removed.
8. **Important:** Fix your shed down to its foundations. If your foundations are unlevel or bowed, you will have problems with your padbolt and door levels. This can be fixed by slipping a spade under either door jamb and lifting. You will soon get a feel for which side needs propping up.

Important

- Do not attempt to assemble panels in rain or windy conditions.
- Make sure your foundations are squared and level before erecting panels.
- It is easier to remove all swarf (filings) before you stand your walls up.
- Complete all panels before erecting your shed.
- Keep a firm grip on panels when handling. If they slip they will cause damage.
- Always wear non-slip gloves, protective footwear and eyewear.

diagram 1

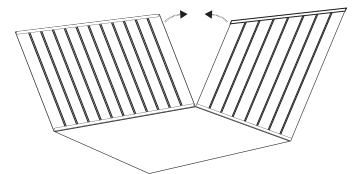

diagram 2

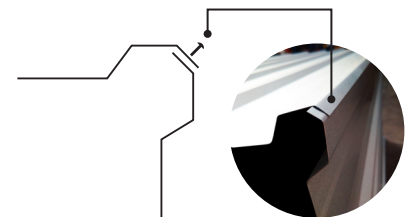

diagram 3

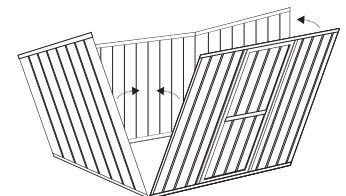
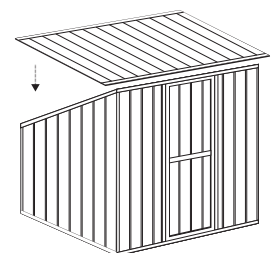

diagram 4



Important

It is essential that every shed has a floor, but the only way to make sure your shed is there to stay on windy sites is with a recessed concrete floor. Phone 0800 807 433 for free advice. See page 6 for more details.

Tip

Use the handle end of a hammer in the inside of the corner, but beware of drilling holes on the end of your hammer.

Recessed concrete floor plan for specially poured concrete floors

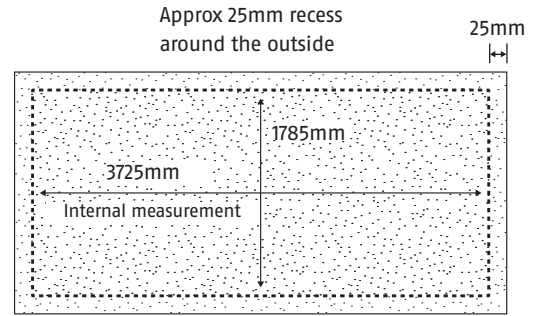
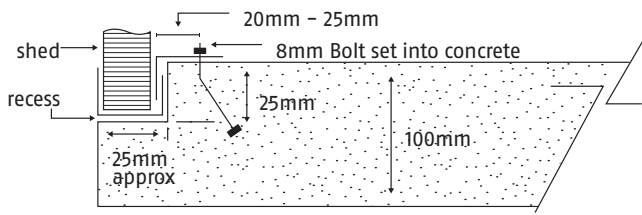

Boxing Diagram

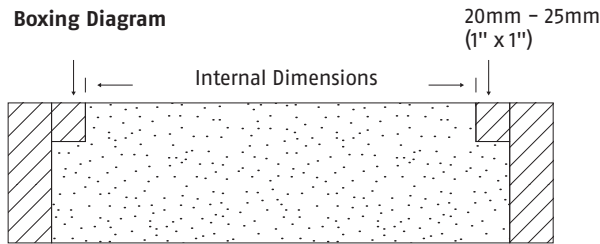

Internal dimensions for the GM3818:
3725mm x 1785mm

Recessed floor clamps

For poured floors with a recess around the perimeter.

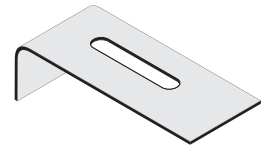

Flat floor clamps

For existing concrete only. Water can seep underneath.

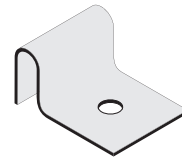

Garden Master kitset wooden floors

Every shed must have a floor

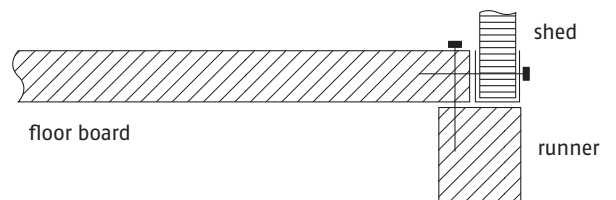
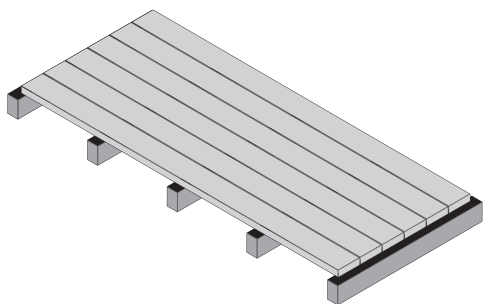

Peg the floor to the ground in a windy area.

Garden Master accessories

We also offer a great range of accessories and extras to complement your new Garden Master Shed. Please ask at your nearest hardware store for further details.

Options Include:

- Tool racks
- Shelving
- GM Securi-door
- Locking T-handle
- Cabin Hook

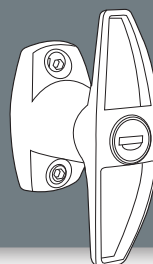

If you choose to vary from these instructions your warranty will be impaired.



If you need advice, call us FREE on 0800 807 433 or email us at info@gardenmastersheds.co.nz



25 Year Warranty

If any component of your shed fails – we will replace it!

Make sure your shed is built and secured according to our instructions as a minimum.

The warranty does not cover damage or loss through an act of God. Please inform your insurance provider.

Call us on 0800 807 433
for tips on high wind sites.

We would like your feedback

Please email your comments to feedback@gardenmastersheds.co.nz or fax us on 06 878 5758. Customer satisfaction is our top priority and we are always on the look out for ways in which we could do better.

Free gift

To receive a **free gift**, include your details when you send in your feedback or send in a photo of your finished shed with your details.

To help you we have listed some questions that you may like to answer:

There is no need to type every question, only the question number and your answers are necessary.

1. How did you find out about us?
2. If you found us through our website, was it easy to navigate?
3. Did you find the assembly instructions and the DVD easy to follow?
4. Where did you purchase your shed?
5. Was the sales person helpful and courteous?
6. What did you like best about your garden shed purchase?
7. Are there any parts of our service that you think we could improve upon?

Thanks for your help!